

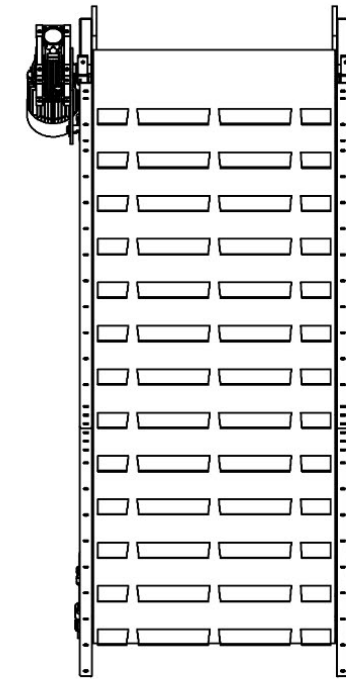

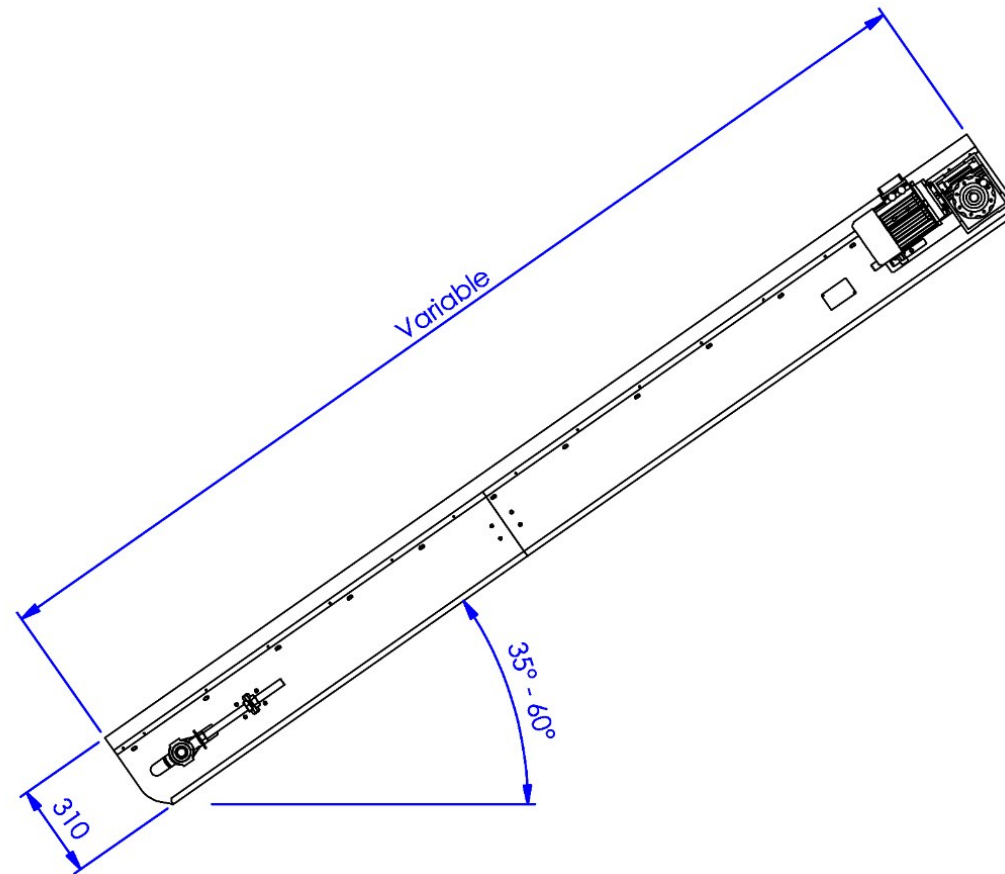

ELR

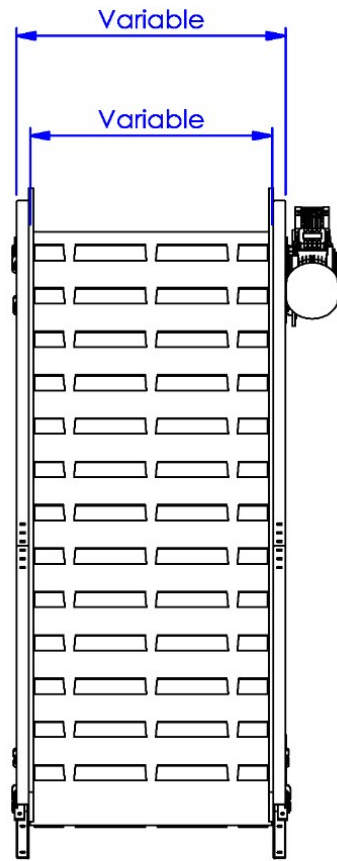
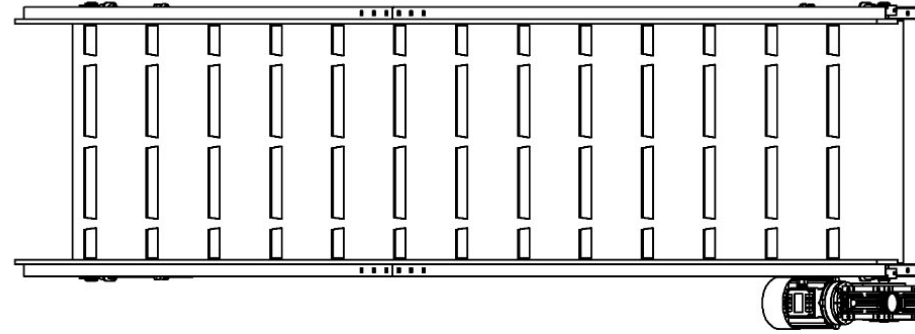
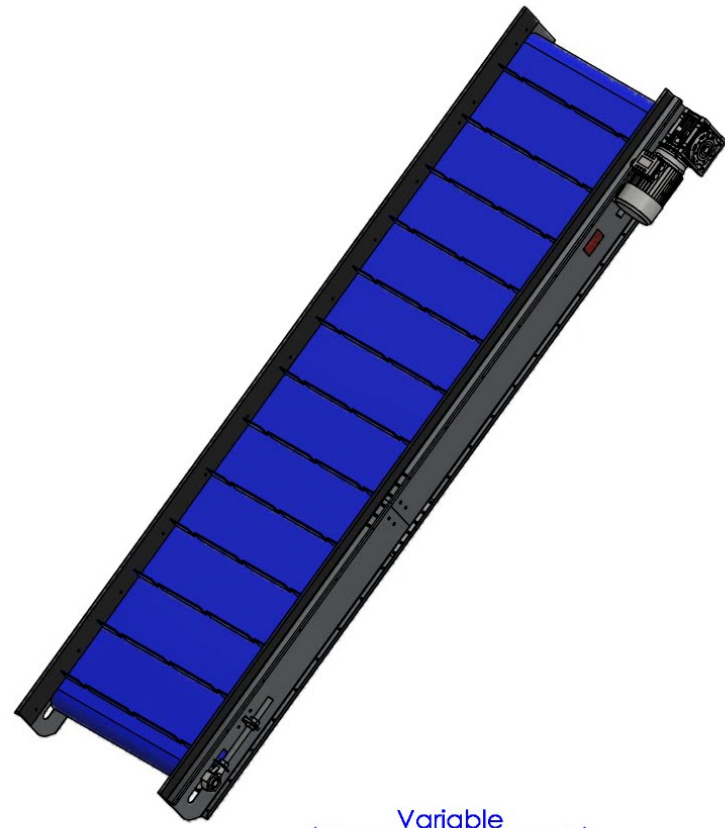

For discussion only!
 The dimensions are approximately.
 We are free to resize and change the machines,
 when we deem it necessary.

Tol principle: ISO 8015		General tolerances: ISO 20768		Fit system: ISO 286		Geometrical tolerancing: ISO 1101	
 		Project: Elevator					
		Description: ELR 350-80					
		Surface:					
		Engineer: S.Iaan	Scale: 1 : 25	00018558		Revision: 00	
		Date: 4-6-2019	Sheet size: A3				
				Unit: mm	Sheet: 1 of 2		