

A2 (Big door)

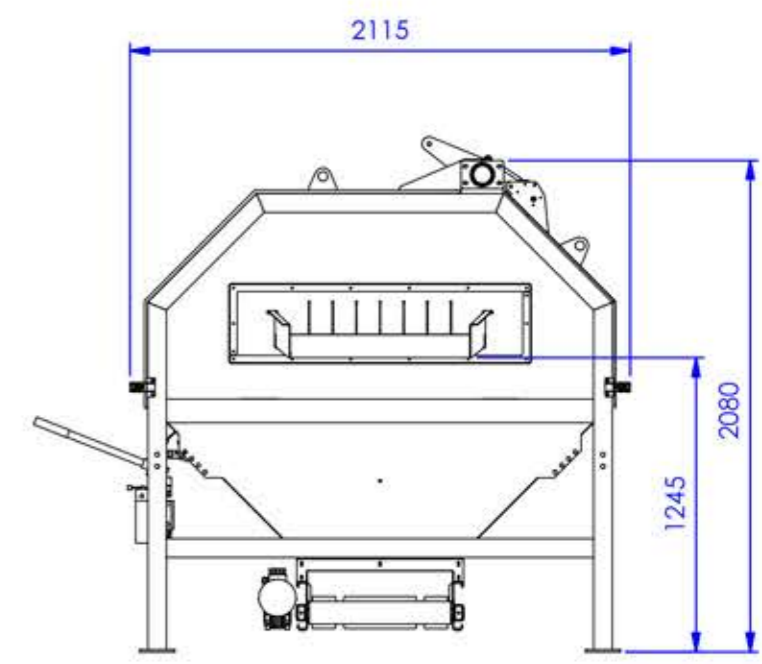

For discussion only!
 The dimensions are approximately.
 We are free to resize and change the machines,
 when we deem it necessary.

Tol principle: ISO 8015	General tolerances: ISO 20768	Fit system: ISO 286	Geometrical tolerancing: ISO 1101
Project: Onion Topper			
Description: A2			
Surface:			
Engineer: SRPL	Scale: 1 : 32	00034106	Revision: 02
Date: 28-6-2019	Sheet size: A3		
Unit: mm		Sheet: 2 of 8	

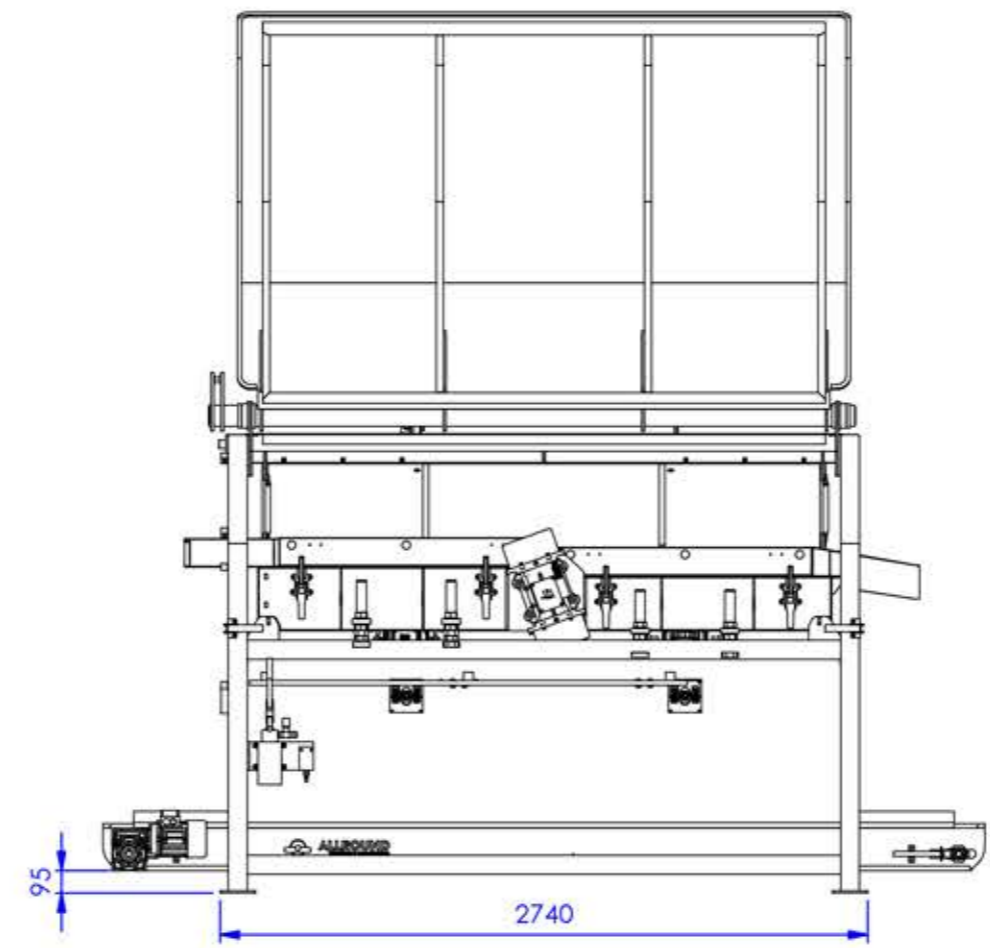
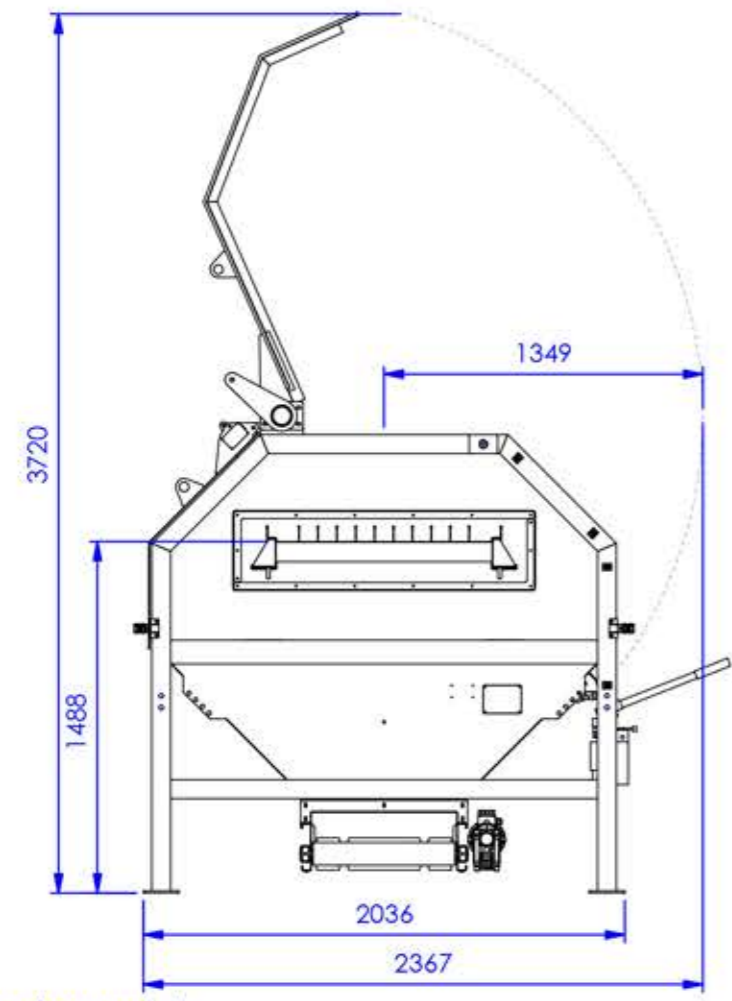
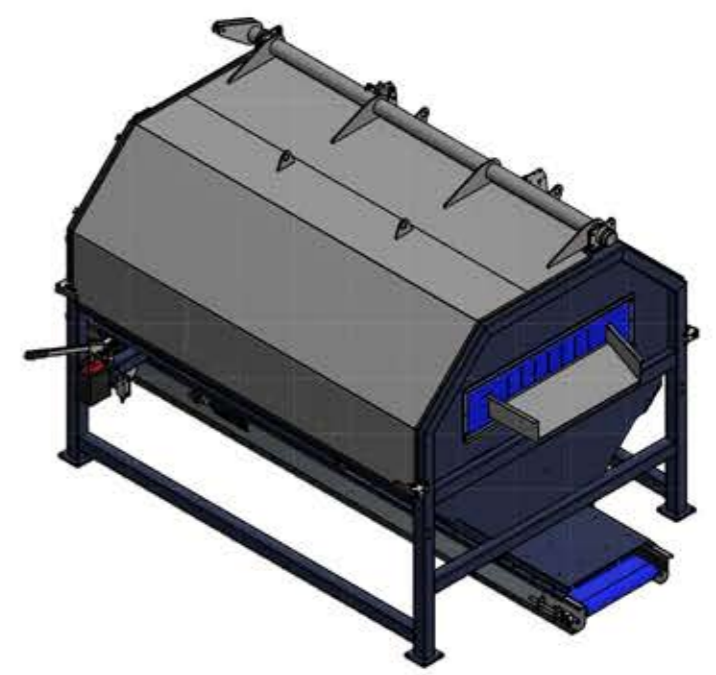
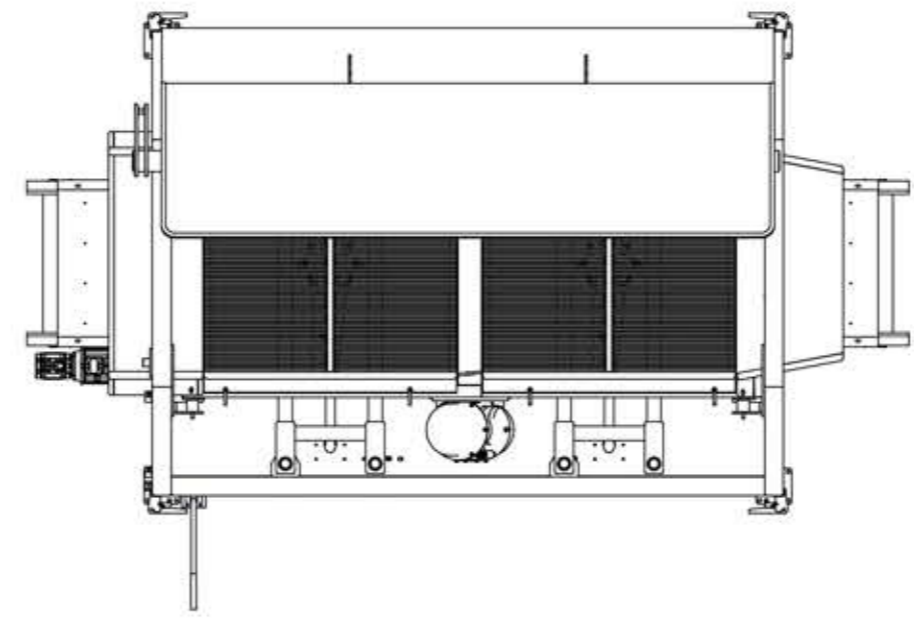